

NUF2230XV6

2 Line EMI Filter with ESD Protection

This device is a 2 line EMI filter array for wireless applications. Greater than -30 dB attenuation is obtained at frequencies from 800 MHz to 900 MHz. It also offers ESD protection—clamping transients from static discharges. ESD protection is provided across all capacitors.

Features

- EMI Filtering and ESD Protection
- Integration of 10 Discrete Components
- Compliance with IEC61000-4-2 (Level 4)
> 8.0 kV (Contact)
- SOT-563 Package
- Moisture Sensitivity Level 1
- ESD Ratings: Machine Model = C
Human Body Model = 3B
- These are Pb-Free Devices

Benefits

- Reduces EMI/RFI Emissions on a Data Line
- Integrated Solution Offers Cost and Space Savings in a SOT-563 Package
- Reduces Parasitic Inductances Which Offer a More “Ideal” Low Pass Filter Response
- Integrated Solution Improves System Reliability

Applications

- EMI Filtering and ESD Protection for Data Lines
- Wireless Phones
- PDAs and Handheld Products
- Notebook Computers
- LCD Displays



ON Semiconductor®

<http://onsemi.com>

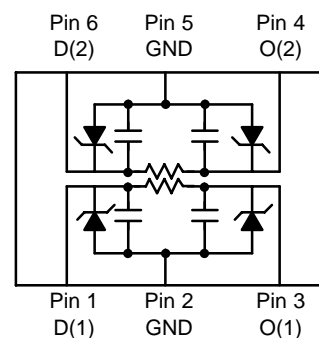

MARKING DIAGRAM

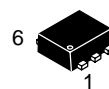

**SOT-563
CASE 463A**

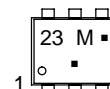

23 = Specific Device Code
M = Month Code
▪ = Pb-Free Package
(Note: Microdot may be in either location)

ORDERING INFORMATION

Device	Package	Shipping†
NUF2230XV6T1	SOT-563	4000/Tape & Reel
NUF2230XV6T1G	SOT-563	4000/Tape & Reel

†For information on tape and reel specifications, including part orientation and tape sizes, please refer to our Tape and Reel Packaging Specification Brochure, BRD8011/D.

NUF2230XV6

MAXIMUM RATINGS ($T_J = 25^\circ\text{C}$ unless otherwise noted)

Parameter	Symbol	Value	Unit
ESD Discharge IEC61000-4-2 Air Discharge Contact Discharge	V_{PP}	15 8.0	kV
Steady-State Power per Resistor	P_R		mW
Steady-State Power per Package	P_T		mW
Operating Temperature Range	T_{OP}	-40 to 85	$^\circ\text{C}$
Storage Temperature Range	T_{STG}	-55 to 150	$^\circ\text{C}$
Maximum Lead Temperature for Soldering Purposes (1.8 in from case for 10 seconds)	T_L	260	$^\circ\text{C}$

Maximum ratings are those values beyond which device damage can occur. Maximum ratings applied to the device are individual stress limit values (not normal operating conditions) and are not valid simultaneously. If these limits are exceeded, device functional operation is not implied, damage may occur and reliability may be affected.

ELECTRICAL CHARACTERISTICS ($T_J = 25^\circ\text{C}$ unless otherwise noted)

Parameter	Symbol	Test Conditions	Min	Typ	Max	Unit
Maximum Reverse Working Voltage	V_{RWM}				5.0	V
Breakdown Voltage	V_{BR}	$I_R = 1.0\text{ mA}$	6.0	7.0		V
Leakage Current	I_R	$V_{RWM} = 3.0\text{ V}$			1.0	μA
Resistance	R_A	$I_R = 20\text{ mA}$	90	100	110	Ω
Capacitance (Notes 1 and 2)	Cd	$V_R = 2.5\text{ V}$, $f = 1.0\text{ MHz}$		16		pF
Cut-Off Frequency (Note 3)	f_{3dB}	Above this frequency, appreciable attenuation occurs		125		MHz

1. Measured at 25°C , $V_R = 2.5\text{ V}$, $f = 1.0\text{ MHz}$.
2. Total line capacitance is 2 times the Diode Capacitance (Cd).
3. $50\ \Omega$ source and $50\ \Omega$ load termination.

NUF2230XV6

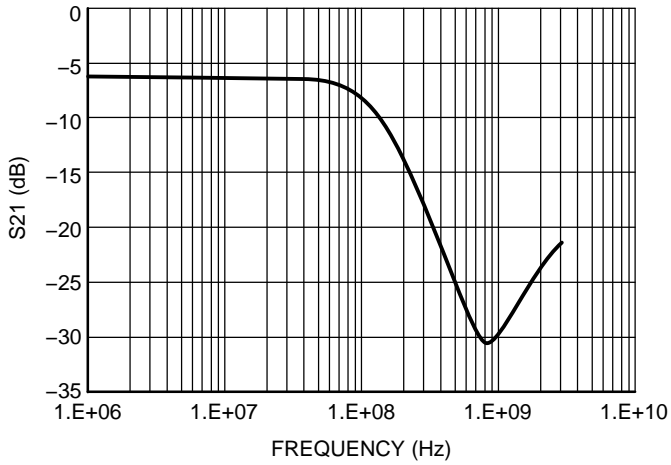

**Figure 1. Insertion Loss Characteristic
(50 Ω Source and 50 Ω Lead Termination)**

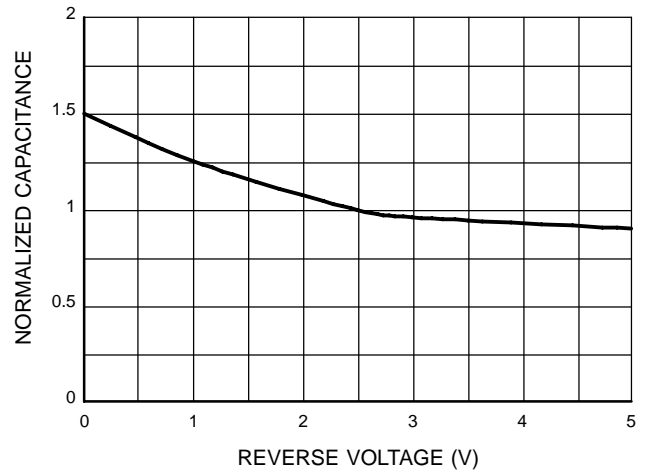

**Figure 2. Typical Capacitance vs.
Reverse Biased Voltage
(Normalized Capacitance, Cd @ 2.5 V)**

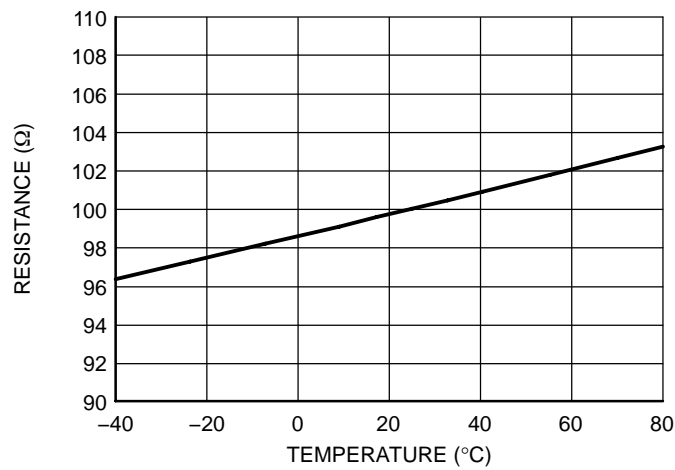

Figure 3. Typical Resistance over Temperature

NUF2230XV6

PACKAGE DIMENSIONS

SOT-563, 6 LEAD

CASE 463A-01

ISSUE F

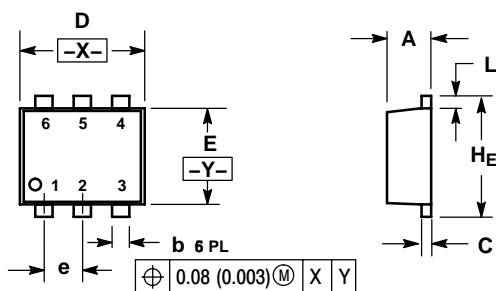

NOTES:

1. DIMENSIONING AND TOLERANCING PER ANSI Y14.5M, 1982.
2. CONTROLLING DIMENSION: MILLIMETERS
3. MAXIMUM LEAD THICKNESS INCLUDES LEAD FINISH THICKNESS. MINIMUM LEAD THICKNESS IS THE MINIMUM THICKNESS OF BASE MATERIAL.

DIM	MILLIMETERS			INCHES		
	MIN	NOM	MAX	MIN	NOM	MAX
A	0.50	0.55	0.60	0.020	0.021	0.023
b	0.17	0.22	0.27	0.007	0.009	0.011
C	0.08	0.12	0.18	0.003	0.005	0.007
D	1.50	1.60	1.70	0.059	0.062	0.066
E	1.10	1.20	1.30	0.043	0.047	0.051
e	0.5 BSC			0.02 BSC		
L	0.10	0.20	0.30	0.004	0.008	0.012
HE	1.50	1.60	1.70	0.059	0.062	0.066

SOLDERING FOOTPRINT*

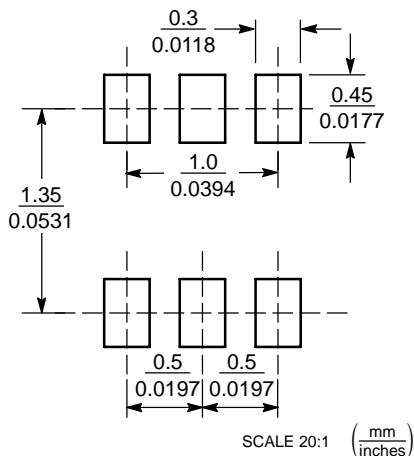

*For additional information on our Pb-Free strategy and soldering details, please download the ON Semiconductor Soldering and Mounting Techniques Reference Manual, SOLDERRM/D.

ON Semiconductor and are registered trademarks of Semiconductor Components Industries, LLC (SCILLC). SCILLC reserves the right to make changes without further notice to any products herein. SCILLC makes no warranty, representation or guarantee regarding the suitability of its products for any particular purpose, nor does SCILLC assume any liability arising out of the application or use of any product or circuit, and specifically disclaims any and all liability, including without limitation special, consequential or incidental damages. "Typical" parameters which may be provided in SCILLC data sheets and/or specifications can and do vary in different applications and actual performance may vary over time. All operating parameters, including "Typicals" must be validated for each customer application by customer's technical experts. SCILLC does not convey any license under its patent rights nor the rights of others. SCILLC products are not designed, intended, or authorized for use as components in systems intended for surgical implant into the body, or other applications intended to support or sustain life, or for any other application in which the failure of the SCILLC product could create a situation where personal injury or death may occur. Should Buyer purchase or use SCILLC products for any such unintended or unauthorized application, Buyer shall indemnify and hold SCILLC and its officers, employees, subsidiaries, affiliates, and distributors harmless against all claims, costs, damages, and expenses, and reasonable attorney fees arising out of, directly or indirectly, any claim of personal injury or death associated with such unintended or unauthorized use, even if such claim alleges that SCILLC was negligent regarding the design or manufacture of the part. SCILLC is an Equal Opportunity/Affirmative Action Employer. This literature is subject to all applicable copyright laws and is not for resale in any manner.

PUBLICATION ORDERING INFORMATION

LITERATURE FULFILLMENT:

Literature Distribution Center for ON Semiconductor
P.O. Box 61312, Phoenix, Arizona 85082-1312 USA
Phone: 480-829-7710 or 800-344-3860 Toll Free USA/Canada
Fax: 480-829-7709 or 800-344-3867 Toll Free USA/Canada
Email: orderlit@onsemi.com

N. American Technical Support: 800-282-9855 Toll Free
USA/Canada

Japan: ON Semiconductor, Japan Customer Focus Center
2-9-1 Kamimeguro, Meguro-ku, Tokyo, Japan 153-0051
Phone: 81-3-5773-3850

ON Semiconductor Website: <http://onsemi.com>

Order Literature: <http://www.onsemi.com/litorder>

For additional information, please contact your local Sales Representative.